



Parrot MKi9200

User guide

Contents

Contents	2
Installation	4
Before you begin	4
Checking the car configuration	4
Caution.....	4
Removing the car stereo.....	4
Installing the kit.....	5
Car stereo with ISO connectors	5
Car stereo with line-in.....	6
Installing the electronic box.....	6
Installing the kit's power cable	7
Checking the wiring	7
Installing the audio connectors.....	7
Installing the individual components	8
Installing the double microphone.....	8
Installing the remote control	9
Installing the screen	10
Getting started	12
Navigating through the menus	12
Associating the remote control to the electronic box	12
Commands	13
Using the vocal menus	13
Establishing a Bluetooth connection with a phone.....	14
Using a phone with the Parrot MKi9200 for the first time	14
Using the Parrot MKi9200 with 2 phones	15
Managing Bluetooth devices	16
Synchronizing the phonebook	17
Display	18
Icons.....	18
Modifying the display parameters	18
Changing the wallpaper	19
Phone	20
Making and receiving calls	20
Making a call	20
Receiving a call.....	21
Using the Parrot MKi9200 while on a call.....	21
Using voice recognition	23
Receiving a call via voice recognition.....	23
Making a call via voice recognition	23
Settings.....	24
Ringtone.....	24
Phonebook.....	25
Call	25
Activating the external noise elimination	26

Music	28
Using the Parrot MKi9200 with an external source	28
Using the Parrot MKi9200 with an iPod / iPhone	28
Using the Parrot MKi9200 with an SD card.....	29
Using the Parrot MKi9200 with a USB peripheral.....	30
Using the Parrot MKi9200 with an audio player connected via Bluetooth	30
Using the Parrot MKi9200 with an analogue audio player	31
Commands	32
Settings.....	33
Covers display	33
Modifying audio settings	33

WARNING: We advise our customers to have the Parrot MKi9200 fitted by a professional.

Before you begin

Checking the car configuration

- The cables supplied with the kit feature ISO connectors and two pairs of line-out jacks. The line-out jacks can be used if your audio system features this option (use of an amplifier). Several set-ups are therefore possible depending on the type of car stereo and your vehicle.
- If your car stereo is not fitted with ISO connectors, you need to purchase an ISO adapter cable to simplify the wiring procedure. Refer to the range of ISO adapters on our website.

Caution

- Unplug the battery before installing the kit's power cable.
- Before you install the individual components, check that the installation locations have been selected in such a way that the cable length is sufficient to connect every element.
- Do not install any component (screen, remote control...) in the airbag deployment area.
- Once the installation is complete, make sure that no cables are pinched or trapped.

Removing the car stereo

- Remove your car stereo from your vehicle. You may need release keys to do so.
 - ▶ Refer to your car stereo user guide or contact your car dealer for more information.
- Remove the audio system from your vehicle's dashboard to access the wiring harness.
- The mute function is used to cut the sound of your car stereo to enable a phone call. The choice of the mute-in jack depends on your car stereo's configuration.

Installing the kit

Note : If you have the possibility to use a multimeter, test and verify all connections on the vehicle before connecting the Parrot MKi9200 wiring loom.

Car stereo with ISO connectors

1. Connect the male connectors of the hands-free kit to the car stereo.
2. Join the vehicle's audio and power supply cables to the female connectors of the Parrot MKi9200.
3. On the installation cable, connect the free yellow wire to one of the audio system's corresponding mute-in jacks if available (mute in 1, mute in 2 or mute in 3).

Note : Mute in 1, mute in 2 and mute in 3 are only suggested mute locations. You first have to test and verify the mute on the vehicle.

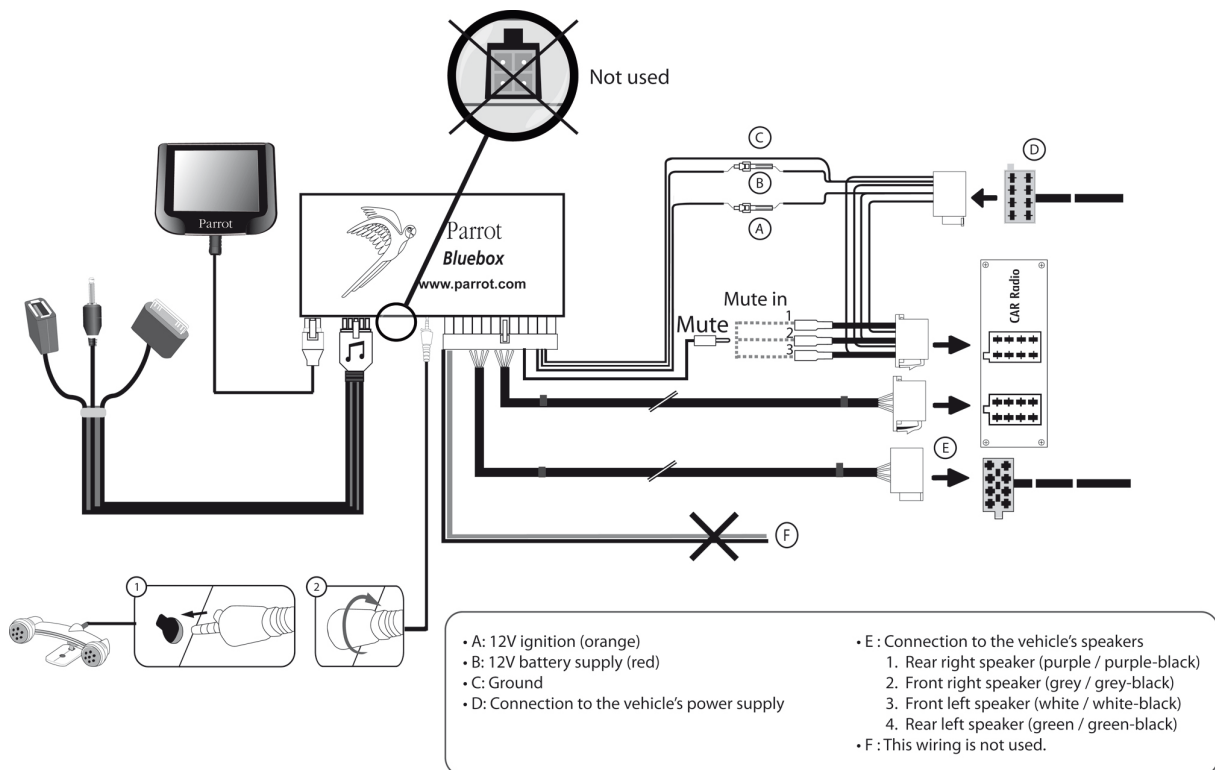

Car stereo with line-in

- Use this type of connection by wiring the line-out (brown & white wire or red & black wire) to your car stereo's line-in.
- Using the two pairs of line-out will enable you to take advantage of the music function in stereo over your vehicle's speakers.
- On the installation cable, connect the free yellow wire to the corresponding audio system's mute-input if available (mute in 1, mute in 2 or mute in 3).

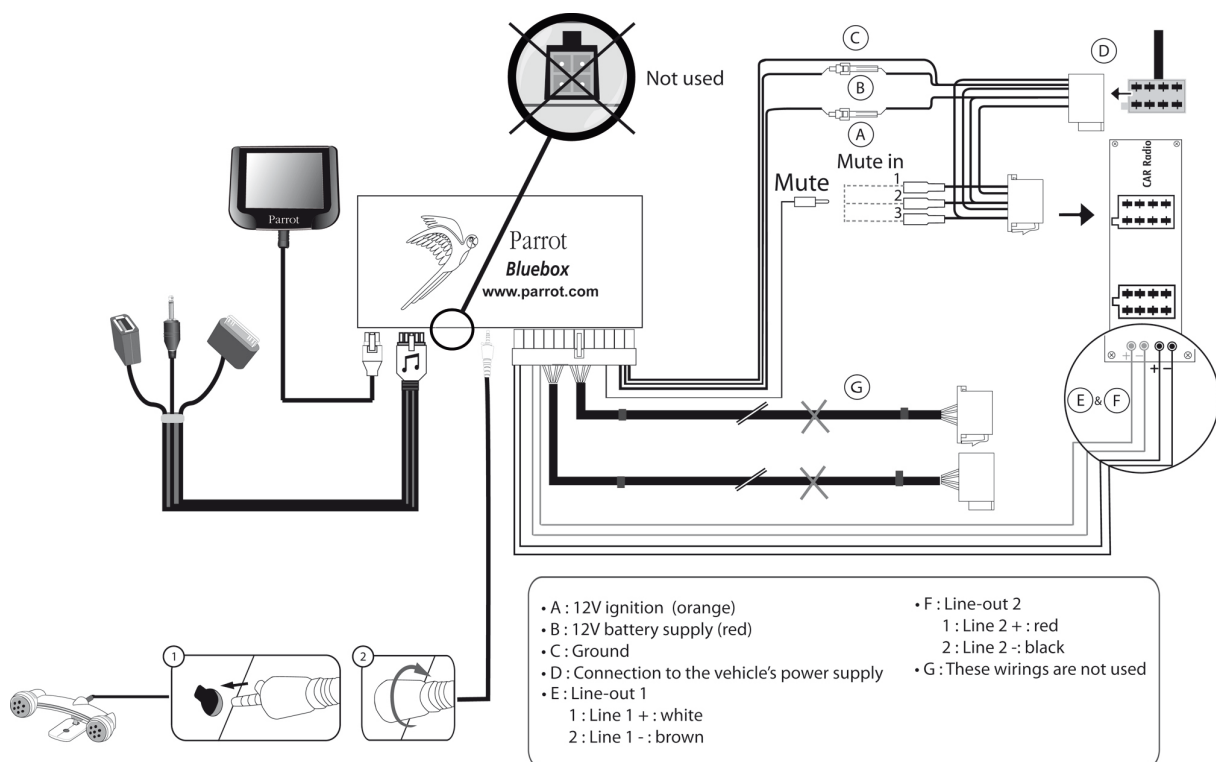

Installing the electronic box

- Avoid installing the electronic box near heating or air-conditioning system, on a spot directly exposed to sunlight or behind metal walls.
- Make sure the electronic box stays fixed once it is installed and that it will not move while you are driving.
- Do not reinstall the car stereo forcibly. If you are short of space behind the car stereo to install the electronic box, consider installing it in the glove box.

Installing the kit's power cable

Note : In order to check the wiring, connect the screen before placing it on the dashboard.

► Refer to the [Checking the wiring](#) section for more information.

- Refer to your car stereo's wiring diagram.
- The red wire of the kit's cable must correspond to the constant +12V supply, the orange wire to the ignition +12V and the black wire to ground. Check that the orange wire is not connected to the constant +12V supply, as you could run down the vehicle's battery.

Note : On some vehicles, there is no ignition +12V on the vehicle's connectors. You must therefore connect the orange power supply wire to the fuse box or another ignition power source.

Checking the wiring

- To perform the installation check, turn the ignition on then off once the Parrot MKi9200 is installed: the message "Goodbye!" must be displayed.
- If it is not the case, it is necessary to inverse the positions of the red and orange wires. Indeed, the red wire of the power cable must be connected to the permanent 12V, the orange wire to the 12V ignition and the black wire to the ground. This can be done simply by reversing both fuse holders located on the Parrot wiring.

Installing the audio connectors

Installing the music cable

Connect the music cable to the electronic box and place the USB / iPod / Jack connectors into the glove box, the central console or the parcel tray depending on the configuration of your dashboard. Make sure that the cable is not pinched.

Note : Use the provided protection cap to protect the connectors.

Installing the music cable grommet system

The music cable grommet system allows you to adjust the cable length while reducing its wear.

1. Drill a 20 mm hole in your dashboard (glove compartment or parcel tray).
2. Insert manually two flexible arms of the grommet system.
3. Use a flat screwdriver in order to insert the last two arms.
> You can now connect your music cable to the bluebox.

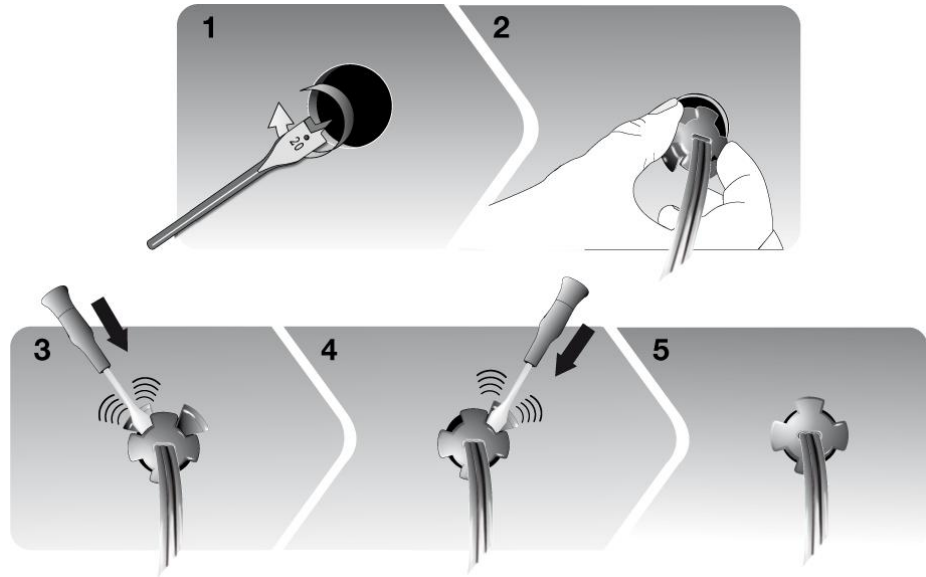

Installing the individual components

Installing the double microphone

Selecting a location

In order to get hi-quality conversations, we advise you to respect the following recommendations:

- Make sure the microphone is installed as close to the mouth of the user as possible. The ideal distance is 60 cm. The best possible location for the microphone is near the rear-view mirror.
- The microphone needs to be pointed towards the user.



$D < 60 \text{ cm}$

$\alpha < 45^\circ$

- Make sure the microphone is not exposed to the air stream from air vents.
- Do not install the microphone cable in heating, ventilation or air conditioning systems.
- Be careful of the side airbags and SRS systems while running the microphone cable.

Mounting the double microphone

- The mounting location for the microphone must be clean and free from grease or dust. Prior to installation, clean the area with an appropriate cleansing product.
- Once you have stuck the support on the dashboard, wait for approximately 2 hours to make sure the adhesive tape adheres well.

Installing the remote control

Installing the remote control on the steering wheel

If you want to place the remote control on the steering wheel, make sure it is securely attached, so that it does not move when you are driving.

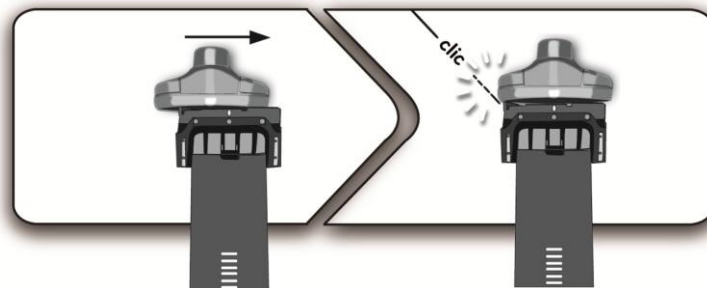

WARNING: Do not install the remote control on the outside of the steering wheel and ensure it does not get in the way when driving.

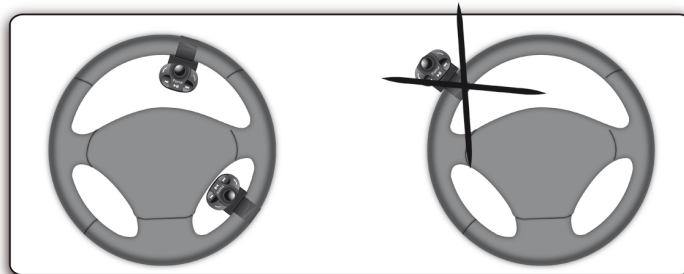

Installing the remote control on the dashboard

If you want to place the remote control on the dashboard, stick the double-sided tape located on the flat side of the bracket to fix it against the dashboard. You can then insert the remote onto the bracket.

WARNING: Once you have stuck the support on the dashboard, wait for approximately 2 hours to make sure the adhesive tape adheres well.

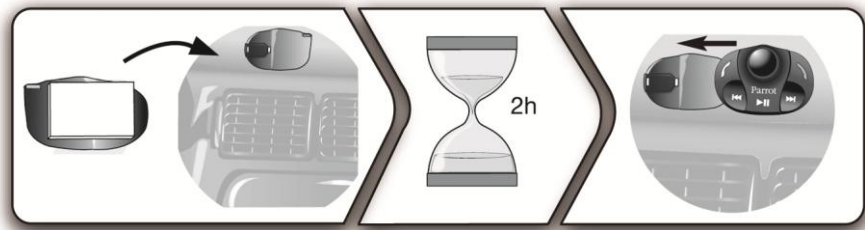

Replacing the battery

- The remote control only works with a 3V CR2032 battery.
- Make sure the battery is correctly positioned before inserting it into the remote control.

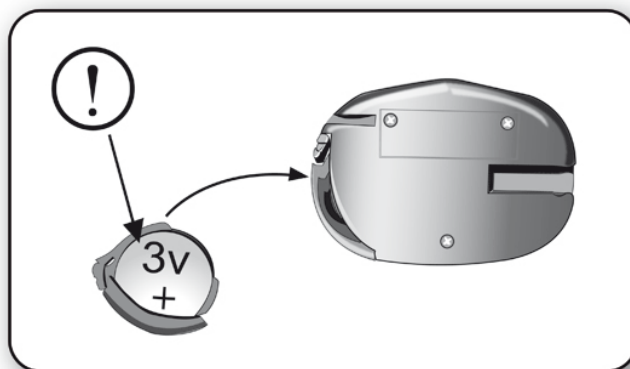

Installing the screen

Selecting a location

- Install the screen in an easily accessible and visible location.
- Do not install the screen in the airbag deployment area or in a possible head impact area.

Mounting the

- The mounting location for the screen must be clean and free from grease or dust. Prior to installation, clean the area with an appropriate cleansing product.

screen

- Once you have stuck the support on the dashboard, wait for approximately 2 hours to make sure the adhesive tape adheres well.

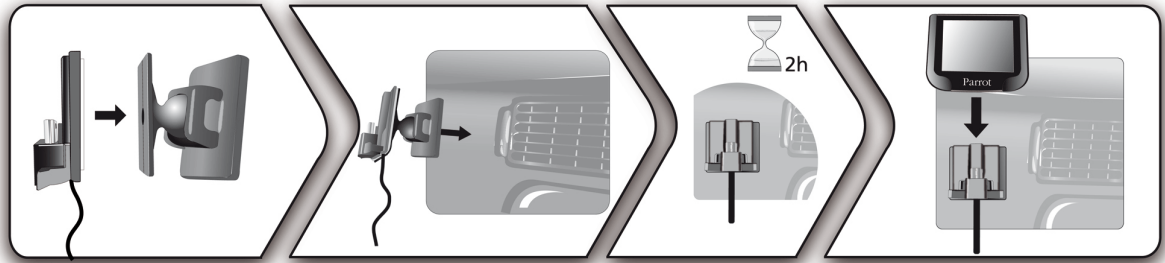

Avoiding theft and sunlight exposure

Remember to remove your screen when leaving the vehicle to avoid tempting any would-be thieves and to prevent prolonged exposure to sunlight.



WARNING : *If the remote control doesn't seem to be associated to the electronic box while using the Parrot MKi for the first time, refer to the [Associating the remote control to the electronic box](#) section.*

Navigating through the menus

Associating the remote control to the electronic box

If the remote control doesn't seem to be associated to the electronic box while using the Parrot MKi9100:



After verifying the CR2032 battery is properly inserted in the remote unit, press and hold the  and  buttons then press the  button several times. This has to be done when you see the "Parrot MKi9100" Logo on the display screen.

Within 1 to 2 seconds, you should then see a "Pairing Remote Control" message displayed on the screen. At that time, you can release the buttons and the remote should then be paired with the kit and the message will go away. You can verify remote operation by navigating through the menus.



Note : *If you are unsuccessful on the first attempt, power off the unit until you see the "Goodbye" message, power it back on, and repeat the process.*

Commands

Accessing the main menu

Press the central jog wheel to access the menus.
> The kit says the name of the current menu.

Browsing through the menus

- Turn the jog wheel to browse through the menus.
- Press the  button or the jog wheel to confirm.
- Press the  button to get back to the previous menu.

Exiting the menu

Press the  button to exit the menu or get back to the Now Playing screen if a song is currently being played.

Using the vocal menus

Activating / deactivating the vocal menus

You can activate or deactivate the vocal menus of the Parrot MKi9200. To do so:

1. Press the jog wheel and select **Settings > Audio > Spoken menus**.
2. Press the jog wheel to activate or deactivate this option.

Adjusting the vocal menu volume

1. Press the jog wheel and select **Settings > Audio > Menu Volume**.
2. Use the jog wheel to adjust the volume and confirm.

Establishing a Bluetooth connection with a phone

Using a phone with the Parrot MKi9200 for the first time

Adjusting the kit visibility

Before pairing your phone with the Parrot MKi9200, make sure that it is visible by all *Bluetooth*® devices. To do so press the jog wheel and select **Settings > Bluetooth > Visibility**. Then, make sure this option is selected. If it is not the case, select it by pressing the jog wheel.

Note : *The Parrot MKi9200 is visible by default.*

Pairing a phone

1. Press the jog wheel and select **Settings > Bluetooth > Pair with...**
 - > If your mobile phone's model appears in the list, select it and confirm by pressing the jog wheel.
 - > If your mobile phone model doesn't appear in the list, select the **Other phones** option.
2. From your phone, search for *Bluetooth* peripherals. Refer to your phone user guide for more information.
 - > The list of the available *Bluetooth* peripherals is displayed.
3. Select « **Parrot MKi9200** » in the list.
4. Enter « **0000** » on your phone when you are prompted to enter a PIN code.
 - > «Pairing successful» is displayed on the screen of the Parrot MKi9200.

Automatic connection

Once your phone is paired to the Parrot MKi9200, the connection between both devices will be automatically established each time you enter your vehicle if your screen is plugged in.

Using the Parrot MKi9200 with 2 phones

Dual mode allows you to simultaneously connect two phones to the Parrot MKi9200.

Activating dual mode To activate dual mode and connect two phones, select **Settings > Bluetooth > Dual mode**.

N.B. Dual mode is deactivated by default.

Connecting two phones to the Parrot MKi9200 When the Parrot MKi9200 is switched on, it attempts to connect all paired phones in the vehicle. If there are more than two paired phones in the vehicle, the device connects the two phones with the oldest pairing.

Main and secondary phones

- When two phones are connected to the Parrot MKi9200, one of them becomes the main phone and the other is the secondary phone.
- By default, the main phone is the one with the oldest pairing to the Parrot MKi9200.
- Your [preferred phone](#) will automatically become the main phone when **dual mode** is activated.
- The information displayed on the Parrot MKi9200 screen is for your main phone.
- To define the secondary phone as your main phone (and make your main phone the new secondary phone), press and hold  for two seconds.

Making and receiving calls

- You can receive calls (manually or through voice recognition) to your main or secondary phones. The Parrot MKi9200 ringtone varies according to the phone receiving the call.
- Only the phonebook for your main phone may be accessed through the Parrot MKi9200. You can only make calls using your main phone. However, you can easily switch between the connected phones by pressing and holding  for two seconds.
- If you receive a call to one of your phones while you are on the other phone, only the latter will ring. You can take the call directly on that phone but not via the Parrot MKi9200.

Managing Bluetooth devices

Defining a phone as preferred phone

The phone which you will define as Preferred is the one whose connection with the Parrot MKi9200 will take priority. This option may be useful if several phones paired with the Parrot MKi9200 are simultaneously in the vehicle.

Note : *Your preferred phone will automatically become the main phone when **dual mode** is activated.*

To define a phone as preferred :

1. Select **Settings > Bluetooth > Paired devices**.
2. Select the phone you want to define as Preferred.
3. Check the **Preferred phone** option.

Disconnecting a phone

1. Press the jog wheel and select **Settings > Bluetooth > Paired devices**.
2. Select the phone you want to disconnect from the kit.
3. Select **Disconnect**.

Connecting an already used phone

The Parrot MKi9200 automatically connects itself to the last phone you used with it. If you want to connect the Parrot MKi9200 to another phone you already paired:

1. Press the jog wheel and select **Settings > Bluetooth > Paired devices**.
2. Select the phone you want to connect to the Parrot MKi9200.
3. Select the **Connect** option.

Managing the “Memory full” problem

You can pair up to 10 devices with the Parrot MKi9200.

If you attempt to pair an 11th phone, you will get the « Memory full » message. You must then delete a phone from the paired devices list. To do so:

1. Press the jog wheel and select **Settings > Bluetooth > Paired devices**.
2. Select the phone you want to delete from the list.
3. Select **Delete**.

Synchronizing the phonebook

Note : Only contacts stored in the memory of the phone will be synchronised in the kit's memory.

Automatic
synchronisation

With most of the *Bluetooth* phones, the phonebook is automatically synchronized in the kit's memory. Refer to the [compatibility section](#) of our website for more information.

WARNING : The automatic synchronization is limited to 2 000 contacts for each paired phone.

Sending contacts
via Object Push

If your phone doesn't support automatic synchronization, you can also send contacts from your mobile to the car kit via Object Push. To do so:

1. Press the jog wheel and select **Phone > Receive contacts**.
2. Refer to your phones 'user guide for more information about sending contacts via Object Push.

Deleting a contact

Note : You can only delete contacts sent via Object Push.

1. Press the jog wheel and select **Phone > Contacts management**.
2. Select the contact you want to delete.
3. Press the jog wheel and select **Delete contact**.





Deleting all
contacts

Note : You can only delete contacts sent via Object Push.

Press the jog wheel and select **Phone > Delete all contacts**.

Display

Icons

- The  and  icons relate to the battery charge level and the status of the network for the telephone connected to the Parrot MKi9200. Whether these icons are present or not depends on which telephone model you have.
- The  icon indicates that synchronisation of the directory is in progress.
- The  icon indicates that your device is in night mode (the screen is dimmer). To exit night mode, press the knob for 2 seconds.
- The icons on the top left show the peripherals connected to the Parrot MKi9200. The highlighted icon shows which audio source is being used.

Modifying the display parameters

Adjusting the brightness

You can adapt the screen brightness of the Parrot MKi9200. To do so :

1. Press the jog wheel and select **Settings > Display > Brightness**.
2. Select **Night mode** or **Day mode**.

Note : You can also adjust the brightness parameter by holding down the jog wheel for 2 seconds.

Changing the display color

1. Press the jog wheel and select **Settings > Display > Theme**.
2. Select the color using the jog wheel.
3. Press the jog wheel to confirm.

Changing the wallpaper

You can change the wallpaper of the Parrot MKi9200 by selecting one of the wallpapers proposed by default. You can also customize it by sending a photo directly to the kit.

- Selecting a wallpaper proposed by default
1. Press the jog wheel and select **Settings > Display > Wallpaper** then use the jog wheel to choose the wallpaper you want to display.
 2. Press the jog wheel to validate.

Customizing the wallpaper

If you want to customize the Parrot MKi9200 wallpaper, you have to send a picture via Bluetooth.

Note: To do so you have to use an image in .jpg format (optimum dimensions: 320px × 240px).

1. Make sure the Parrot MKi9200 is set so that it is visible by all *Bluetooth* devices. To do so, press the jog wheel and select **Settings > Bluetooth > Visibility**.
2. Press the jog wheel then select **Settings > Display > Wallpaper > Customize > Add**.
> « *Waiting for a picture* » is displayed on the Parrot MKi9200.
3. From your *Bluetooth* peripheral, send via *Bluetooth* the image you want to display on the Parrot MKi9200. Refer to your device documentation for more information about sending photos via Bluetooth.

Deleting a wallpaper

To delete a picture sent to the Parrot MKi9200 as wallpaper, press the jog wheel and select **Settings > Display > Wallpaper > Custom > Delete**.

Note : The availability of some functionality only depends on the model of your mobile phone.

Before using your Parrot MKi9200 telephone function, you first have to connect it with your phone / PDA.

► For more information, refer to the [Establishing a Bluetooth connection with a phone](#) section.

Making and receiving calls

The network signal at the top of the screen shows whether you are in range of the cellular network and can make and receive calls. The more bars, the stronger the signal.

Making a call

Calling a contact in the phonebook

If the contact you want to call is in the phonebook of the phone connected to the Parrot MKi9200:

1. Press the jog wheel to enter the main menu and select **Phonebook**.
2. Select a letter and press the jog wheel.
> Once the contact chosen:
 - Press the  button to call this contact.
 - Or use the jog wheel to choose between different numbers of the same contact.

Dialling a number

If the contact you want to call is not in the phonebook of the phone connected to the Parrot MKi9200, stop your vehicle in a safe location, press the jog wheel and select **Phonebook > Dial a number**. You can then use the jog wheel to select the digits.

You can also make the call directly from your phone.

Bringing up the last dialled number

Hold down the  key of the Parrot MKi9200 for two seconds to redial the last dialled number.

Receiving a call

An incoming call is indicated by a ringtone. The name of the caller is announced if their details are stored in the phonebook of the phone connected to the Parrot MKi9200.

Note : You can also associate a picture to a contact. This picture will be displayed each time you receive a call from this contact. Refer to the [Assigning a picture to a contact](#) section for more information.



Answering a call Press the  button to answer an incoming call.

Declining a call Press the  button to decline an incoming call.



Using the Parrot MKi9200 while on a call

Adjusting the volume Use the jog wheel during a call to adjust the communication volume.
> The volume setting is saved for subsequent calls.



Transferring a call to the phone

- During a call, if you want to continue the conversation on your phone (private conversation), press the  button of the Parrot MKi9200.
> The call is automatically transferred to the phone.
- If you want to switch back to the kit, press the  button again.

Muting a call

- If you want to deactivate the microphone during a call, press the  button : you will still hear your caller but your caller will not be able to hear you.
- Press the  button to reactivate it again.

Managing a second call During a call, you can receive another call if your phone supports this functionality.

- Press the  button to accept the second incoming call.
> The first call is automatically put on hold.
- Press the  button to decline the second incoming call.
You can also hang up directly from your phone.
- Press the  button to switch from a call to another.

Managing voice mail

During a call, the Parrot MKi9200 allows you to send DTMFs to manage your voice mail for example. To do so :

1. Press the jog wheel to access the DTMF menu.
> « 0 » is displayed by the kit.
2. Use the jog wheel to select your DTMF between the following possibilities : 0,1,2,3,4,5,6,7,8,9,# or *.
3. Press the jog wheel to send this DTMF to your phone.

Ending a call

Press the  button to end a call.

Using voice recognition

Receiving a call via voice recognition

To receive a call via voice recognition, magic words must be activated.

Activating / deactivating
the magic words

Note : *Magic words are activated by default.*

1. Press the jog wheel and select **Telephone > Voice Commands > Magic words**.
2. Press the jog wheel to activate/deactivate the magic words.

Accepting a call

Say « **Accept** » to answer an incoming call.

Declining a call

Say « **Reject** » to decline an incoming call.

Making a call via voice recognition

Calling a contact with one
phone number

1. Press the  button to launch the voice recognition feature.
> The Parrot MKi9200 asks you the name of the contact you want to call.
2. Say the name of the contact.
> The call is automatically launched if the voice tag is correctly understood.
> If it is not the case, a confirmation message is asked.
3. Confirm if necessary by saying "Yes" or "call".

Calling a contact with several phone numbers

- If there are several phone numbers associated to the contact you want to call, you can specify the type of number.

- To do so, the following vocal commands are available:

- Home
- At home
- Work
- At work
- Office
- At office
- At the office
- Mobile
- Cellular
- Cell
- On mobile
- On cellular
- On cell
- On mobile phone
- On cellular phone
- On cell phone
- Mobile phone
- Cellular phone
- Cell phone
- Other
- General
- Default
- Preferred

Exiting voice recognition mode

Press the  button to exit voice recognition mode.

Settings

Ringtone

To adjust the volume of the ringtone which indicates an incoming call :

1. Press the jog wheel and select **Settings > Audio > Ringtone volume**.
2. Use the jog wheel to adjust the volume.

Phonebook

Downloading photos of contacts

To download photos of contacts from your phone to the Parrot MKi9200, select **Phone > Download photos**.

WARNING: *This feature is only available if you use a phone operating under a Symbian Serie40, Serie60, Windows Mobile or Blackberry system.*

Assigning a picture to a contact

You can assign a picture to a contact. This picture will be displayed each time the contact calls.

1. Press the jog wheel and select **Telephone > Contacts management**.
2. Choose a contact.
3. Press the jog wheel and select **Picture > Add a picture**.
> « Waiting for picture » is displayed.

WARNING:
- *Make sure the picture is in JPG format.*
- *The picture weight must be less than 1Mo.*

Modifying the phonebook style

You can activate / deactivate the contacts pictures display while browsing through your phonebook. To do so:

1. Press the jog wheel and select **Telephone > Advanced settings > Phonebok style**.
2. Select **With picture** or **Without picture**.

Call

Displaying / hiding identification

- If you do not want your phone number to be displayed on your contact's phone while making a call, activate the **Allow #31#** option.
To do so:
 1. Press the jog wheel and select **Telephone > Advanced Settings > Allow #31#**.
 2. Select **Activate**.
- Deactivate the **Allow #31#** option to allow your contacts to see your number while you are calling them.

Making an international call

You can configure the Parrot MKi9200 to add a prefix while making a call from or towards a foreign country. To do so:

1. Press the jog wheel and select **Telephone > Advanced settings > Change + to**.
2. Select the prefix you want to use.

Activating the external noise elimination

- In order to improve the listening comfort of your conversation, the Parrot MKi9200 allows you to tone down the noise from outside your car (motorcycles, trucks) if your window is open.
- To activate / deactivate this setting, press the jog wheel and select **Settings > Audio > Lateral noise detection**.

WARNING: Make sure the double microphone is angled towards the driver before activating the **Lateral noise reduction** effect. If not, the driver's voice will be considered as an external noise.



Lateral noise detection effect activated – Microphone correctly installed



Lateral noise detection effect deactivated – Microphone misplaced

Using the Parrot MKi9200 with an external source

Notes :

- While playing a song, press the  button to get to main menu.
- While navigating through the menus, press the  button to get to the Now Playing screen.

Using the Parrot MKi9200 with an iPod / iPhone



WARNING: Make sure your iPod is updated before using it with the Parrot MKi9200.

Compatibility

- If you are using the Parrot MKi9200 with the iPod Mini, iPod Photo, iPod 3G and iPod Shuffle, then connect your iPod to the Parrot MKi9200 using the Jack cable.
- Use the iPod connector if you are using another model of iPod or an iPhone.

Playing music files

- If your iPod / iPhone is connected to the Parrot MKi9200 via the iPod connector :
 1. Press the jog wheel and select **iPod**.
 2. Select one of the classification criteria (artist, album, songs, genres, playlist) and press the jogwheel.

Note : Use the  and  buttons to navigate more easily through the content of your iPod.

3. Select the song and press the jog wheel.

- If your iPod is connected to the Parrot MKi9200 via the jack cable, refer to the [Using the Parrot MKi9200 with an analogue player](#) section.

Using audio applications with the Parrot MKi9200

- With version 1.95 or later, you can use audio applications like Deezer or Spotify.
- Just select **iPhone > Audio applications**.

Using the Parrot MKi9200 with an SD card

WARNING: In some cases, audio files may not be detected by the Parrot MKi9200. This problem occurs if you have audio files with too high a sampling rate on your SD Card. Songs encoded without loss of audio quality cannot be read/detected by the Parrot MKi9200.

Compatibility

You can use the following SD cards with the Parrot MKi9200:

- SD, micro SD (with adapter), mini SD (with adapter)
- SDHC (class 2, 4, 6), mini SDHC (with adapter), micro SDHC
- MMC, MMC plus, MMC mobile (with adapter), MMC micro (with adapter), RS-MMC mini (with adapter)

Transferring music files onto an SD card

1. Insert the SD card into the appropriate slot.
2. Connect the Parrot MKi9200 to your computer using a USB / mini-USB cable.

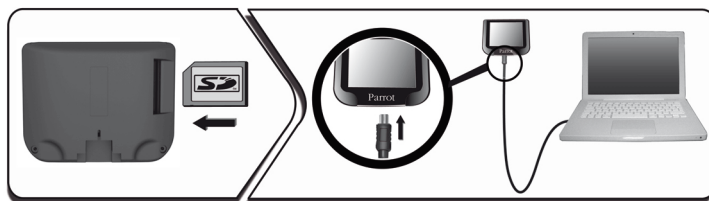



3. Copy your music files in MP3 or WMA formats as if it was a USB flash drive.

Playing music files

1. Insert the SD card into the appropriate slot.
2. Press the jog wheel and select **SD card**.
 - > You access the content of the SD card.
 - If the tags of your audio files are correctly defined, select one of the classification features (artist, album, songs, genres, playlist)

and press the jog wheel.

- If the tags of your audio files are not defined, select **Directories** or **Flat directories**.

Note : Use the  and  buttons to navigate more easily through the content of your SD Card.



3. Select the song and press the jog wheel.

Using the Parrot MKi9200 with a USB peripheral

WARNING:

- ***If your Parrot MKi9200 is connected to an iPhone and an USB flash drive, the iPhone has priority: you can only browse through your iPhone content.***
- ***In some cases, audio files may not be detected by the Parrot MKi9200. This problem occurs if you have audio files with too high a sampling rate on your USB peripheral. Songs encoded without loss of audio quality cannot be read/detected by the Parrot MKi9200.***

1. Connect the USB flash drive or the MP3 player using the USB cable.
2. Press the jog wheel and select **USB**.
 - > You access the content of your USB peripheral.
 - If the tags of your audio files are correctly defined, select one of the classification features (artist, album, songs, genres, playlist) and press the jog wheel.
 - If the tags of your audio files are not defined, select **Directories** or **Flat directories**.

Note : Use the  and  buttons to navigate more easily through the content of your USB flash drive.

3. Select the song and press the jog wheel.

Using the Parrot MKi9200 with an audio player connected via Bluetooth

Compatibility

You can use the Parrot MKi9200 to listen to songs stored on your mobile phone / PDA / smartphone. Your mobile phone must support the *Bluetooth*® A2DP profile (Advanced Audio Distribution Profile).

Playing a music file

- If you are using a Bluetooth audio player for the 1st time, you have to pair both devices.
▶ Refer to the [Pairing a phone](#) section.
- If both devices are already paired :
 1. Press the jog wheel and select **Settings > Bluetooth > Paired devices**.
 2. Choose an audio player and press the jog wheel.
 3. Select **Play Bluetooth audio**.
 4. Get back to main menu and select **Audio Bluetooth**.
 5. Start playing a song on your audio player.









Note : Volume for calls and for streaming audio work separately.

Using the Parrot MKi9200 with an analogue audio player

1. Connect your audio player to the Parrot MKi9200 using the Jack connector.
2. Press the jog wheel and select **Line In**.
3. Start playing a song on your audio player.

WARNING: The Next/Previous tracks functions are not available if the Parrot MKi9200 is connected to the audio player via the Jack connector.

Commands

To do so	Proceed this way
Pause a song	Press the  button.
Resume playback	Press the  button.
Raise or lower the volume	Turn the jog wheel.
Rewind or fast-forward	Hold down the  or  buttons.
Restart a song	Press the  button.
Skip to the next song	Press the  button.
Skip to the previous song	Press the  button twice.
Get to the audio effects menu	Hold down the  button for 2 seconds.

Settings

Covers display

The album covers can be displayed if they are included in the tags of your audio files.

Associating a picture to an album

If no picture is included in the tags of your audio files (MP3 ID3v2), you can add a picture in .jpg format in the corresponding folder. If various pictures are in this folder, the Parrot MKi9200 primarily displays the “cover.jpg” one.

WARNING : The picture size needs to be less than 1Mb.

Selecting the covers display mode

1. Press the jog wheel and select **Settings > Display > Cover**.
2. Select the display mode.
3. Press the jog wheel to confirm.

Deactivate covers display

To deactivate the covers display :

1. Press the jog wheel and select **Settings > Display > Cover**.
2. Select **Disabled**.

Modifying audio settings

Note : While playing a song, hold down the  button for 2 seconds to access to the audio effects menu.

Using the sound stage effect

- The sound stage of the Parrot MKi9200 offers you a three dimensional sound.
- To adjust this setting:
 1. Press the jog wheel then select **Audio effects > Sound stage**.
 2. Press the jog wheel to activate or deactivate this option.
- After having activated the sound stage effect, you can modify its characteristics. To do so, select **Audio Effects > Settings > Sound stage settings**.

Using the equalizer

- The equalizer allows you to adjust the low, medium and high frequencies depending on your preferences. To activate or deactivate it:
 1. Press the jog wheel and select **Audio effects > Equalizer**.
 2. Press the jog wheel to activate or deactivate this option.
- You can choose between 10 default presets to adapt the frequencies to the music style you are listening to. To do so:
 1. Press the jog wheel and select **Audio effects > Settings > Equalizer presets**.
 2. Use the jog wheel to select a preset.

Using the Virtual Super Bass

- The Virtual Super Bass effect allows you to amplify the low frequencies. To activate or deactivate it:
 1. Press the jog wheel and select **Audio effects > Virtual Super Bass**.
 2. Press the jog wheel to activate or deactivate this option.
- You can change the settings of the Virtual Super Bass effect by selecting **Audio effects > Settings > Vsb preferences**..

Setting the Parrot MKi9200 to repeat songs

1. Press the jog wheel and select **Audio effects > Settings > Repeat**.
2. Activate or deactivate the option by pressing the jog wheel.

Note: If you are using the Parrot MKi9200 with an iPod, select **Audio effects > Settings > Repetition (iPod)**. Modifying this option on the Parrot MKi9200 will not modify your iPod settings.

Setting the Parrot MKi9200 to shuffle songs

To activate or deactivate the random playback of the music files:

1. Press the jog wheel and select **Audio effects > Settings > Random**.
2. Activate or deactivate the option by pressing the jog wheel.

Note: If you are using the Parrot MKi9200 with an iPod, select **Audio effects > Settings > Random (iPod)**. Modifying this option on the Parrot MKi9200 will not modify your iPod settings.

Deactivating the Mute on Streaming

- This option automatically mutes the tuner when a song is played. This option is activated by default.
- You can deactivate this option and mute the tuner manually via the Mute cable. To do so, press the jog wheel then select **Settings > Audio > Mute on Streaming**. Press the jog wheel to deactivate this option.