













	<b>SANDERO II</b>	
	<b>SANDERO STEPWAY II</b>	
	<b>LOGAN II</b>	
	<b>SYMBOL</b>	
	<b>MCV II</b>	
	<b>DOKKER</b>	
	<b>LODGY</b>	
	<b>DUSTER II</b>	

**6001998806**

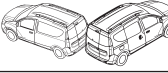

<http://tech-accessoires.renault.com>

# **RO** Instrucțiuni de montaj

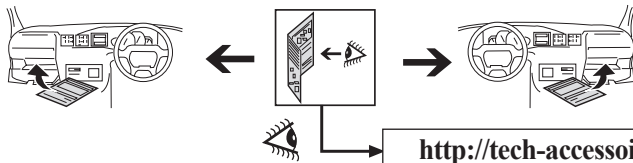
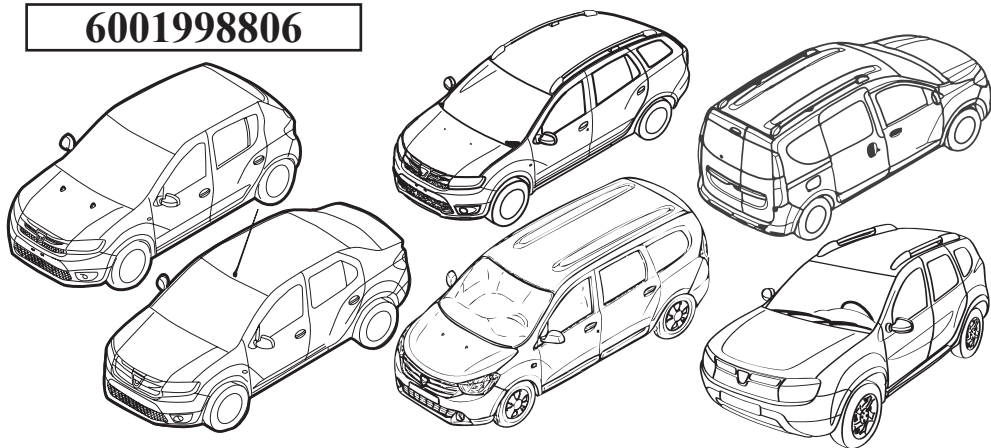

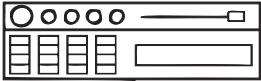
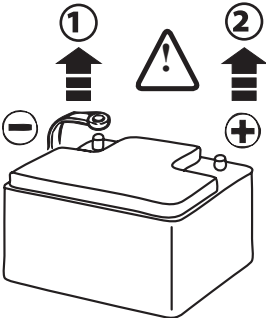
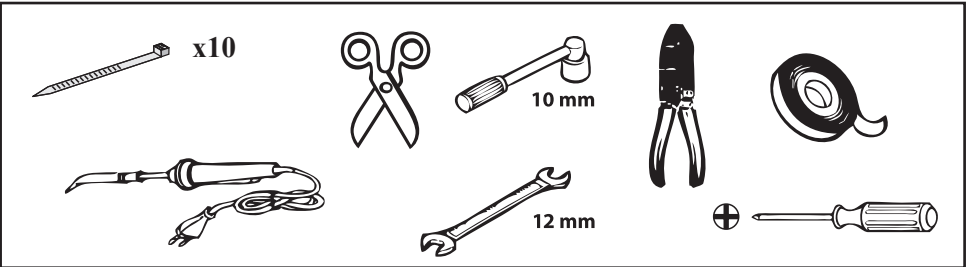
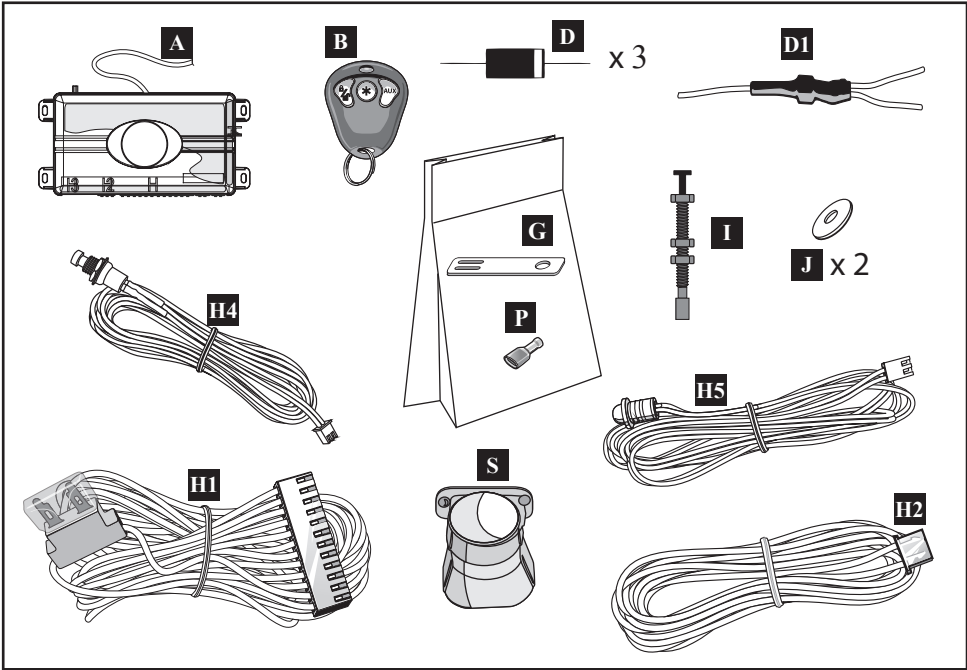

Radio code

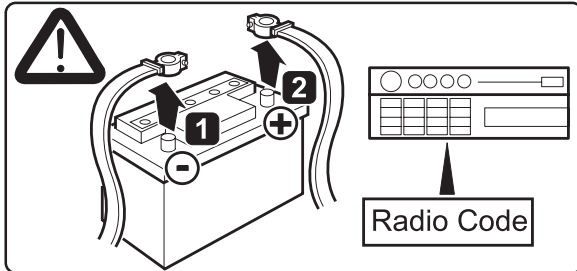
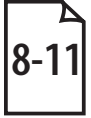
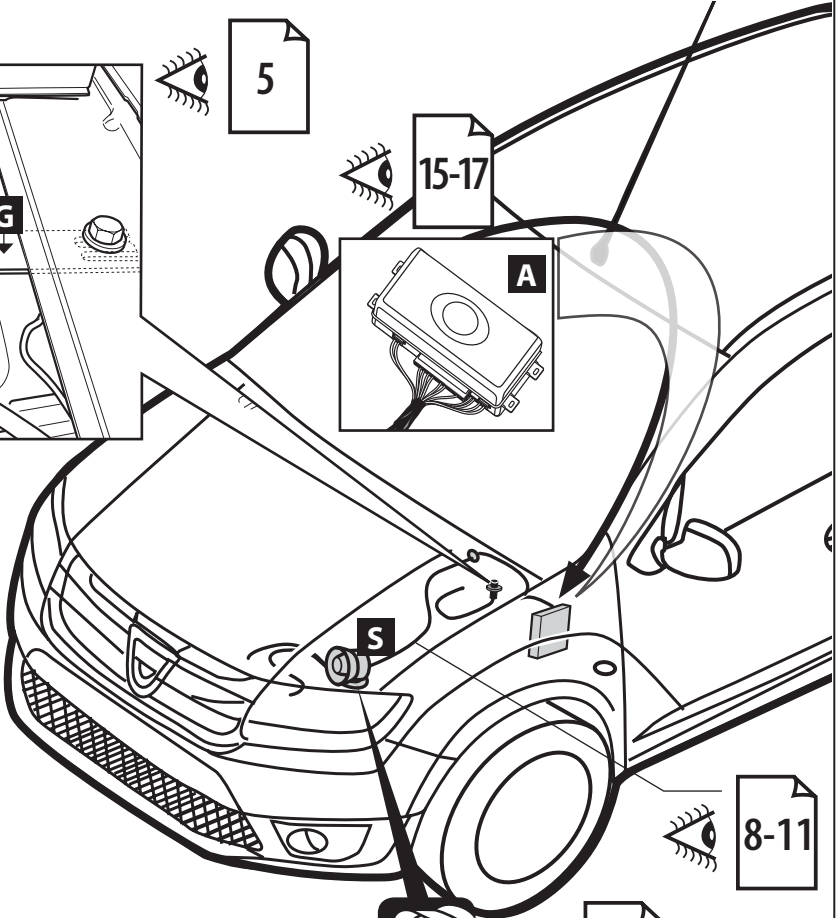
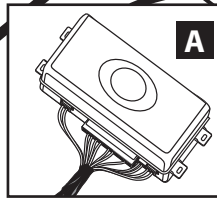
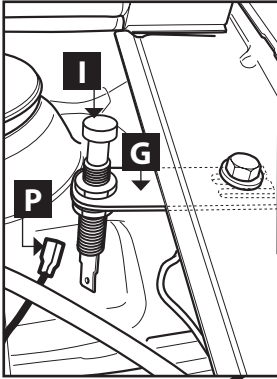



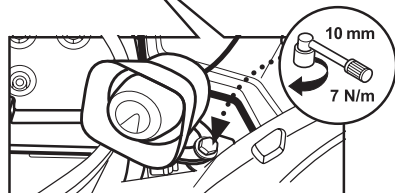
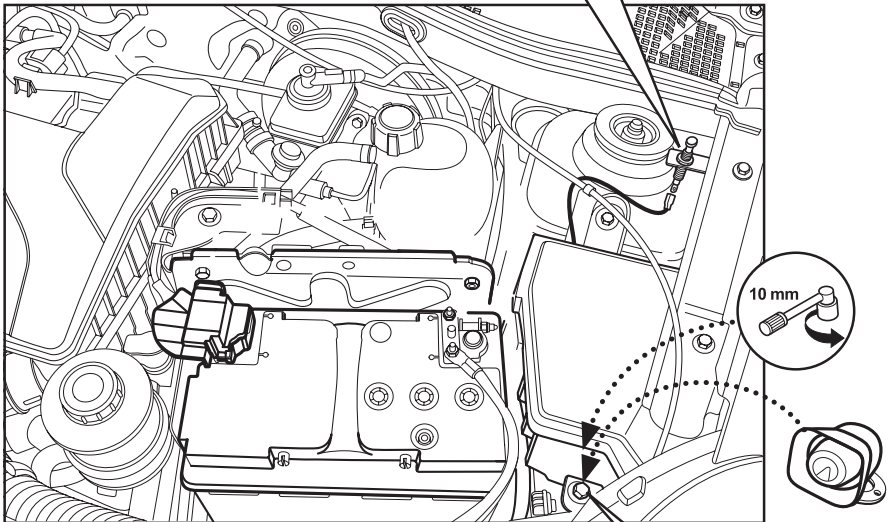
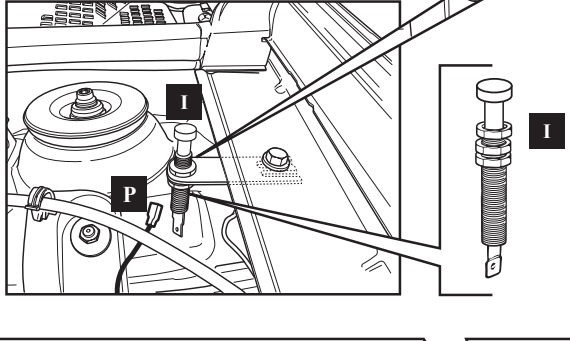
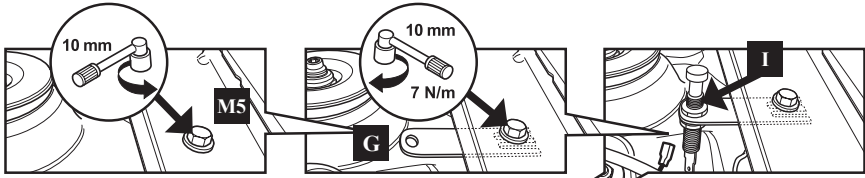



3

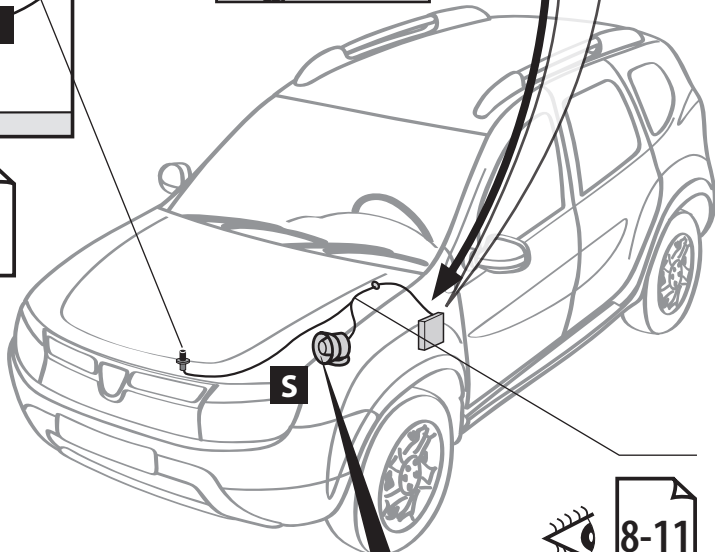
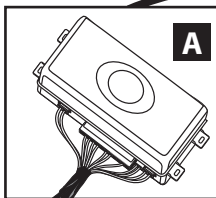
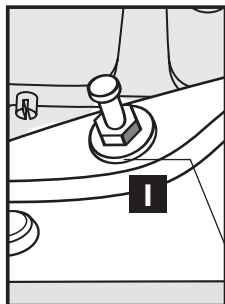

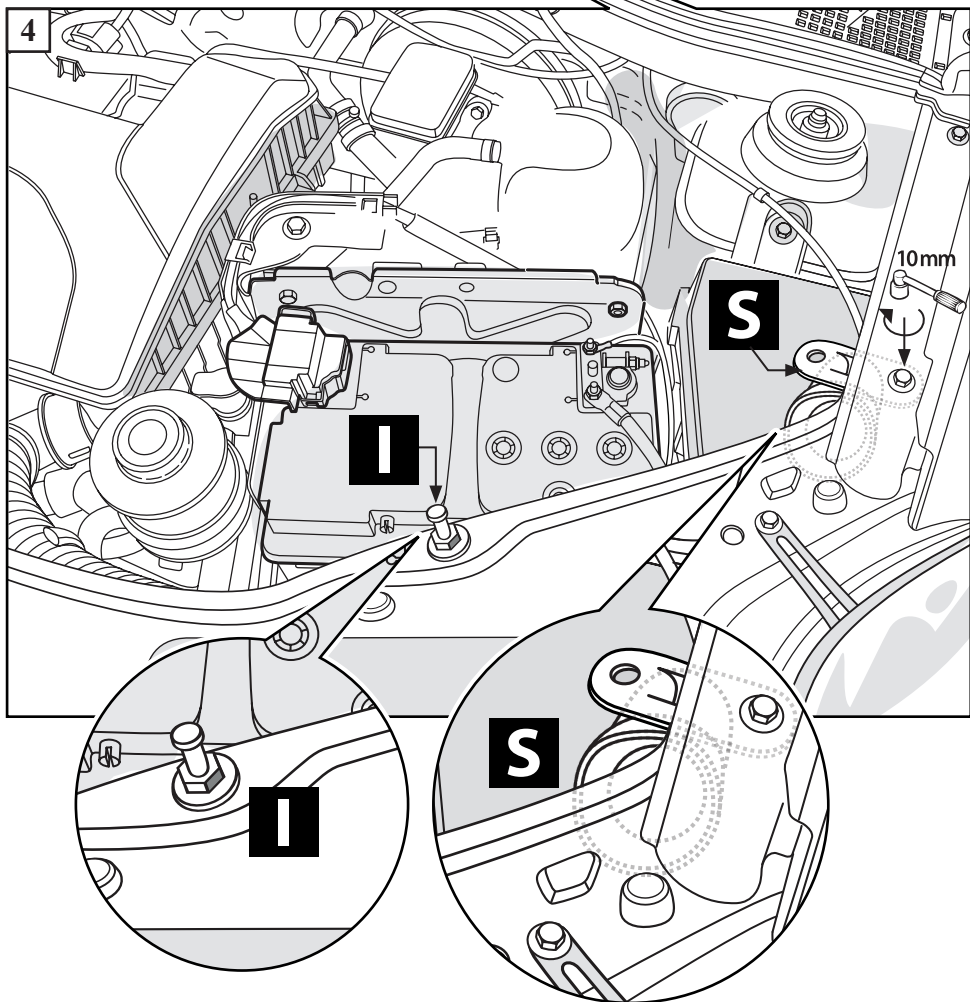
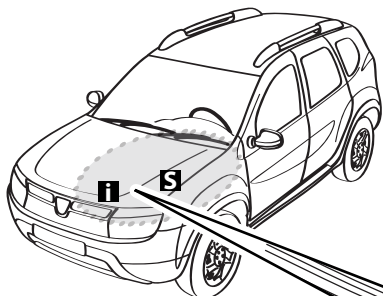

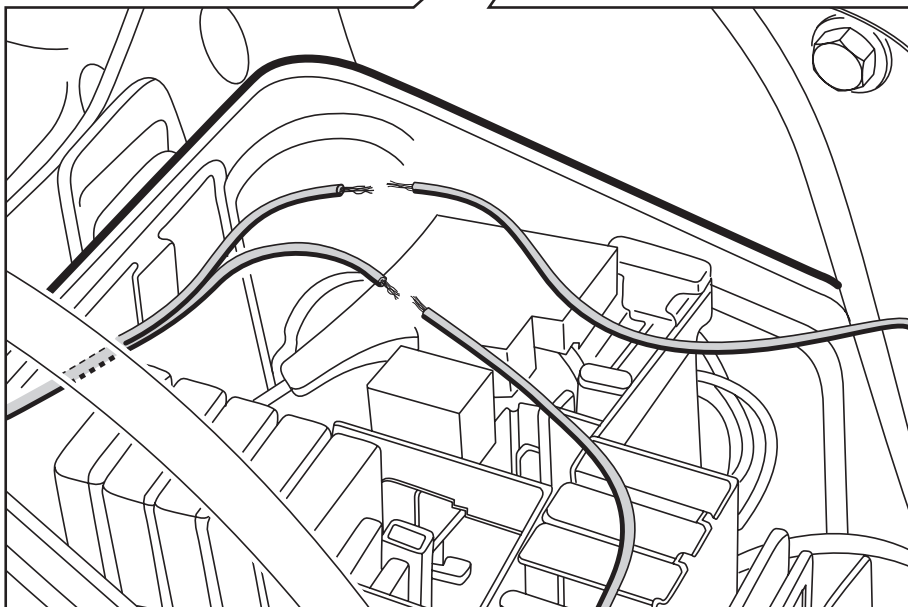
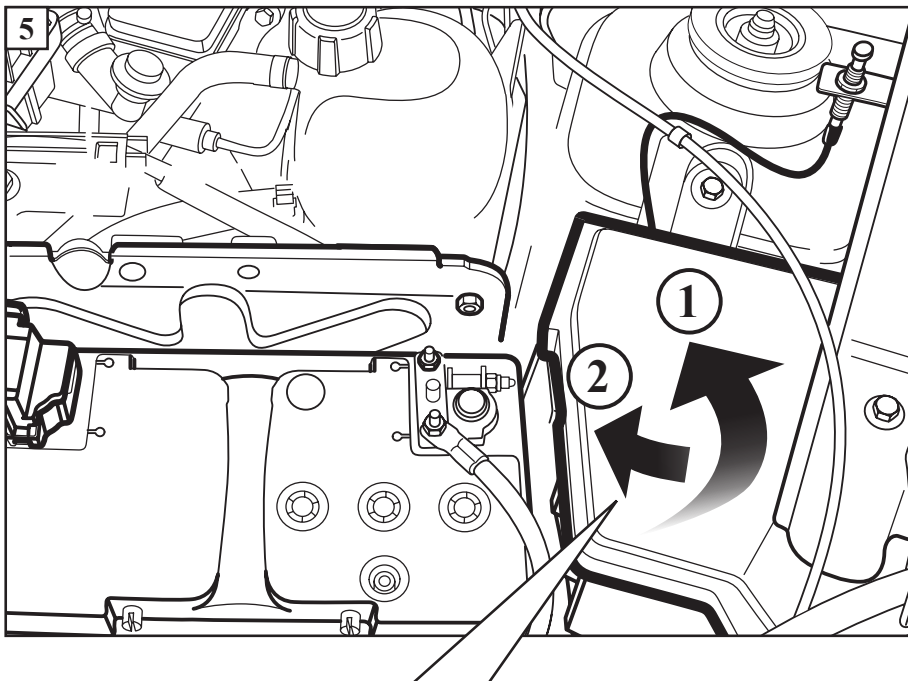

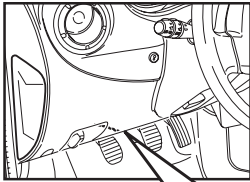
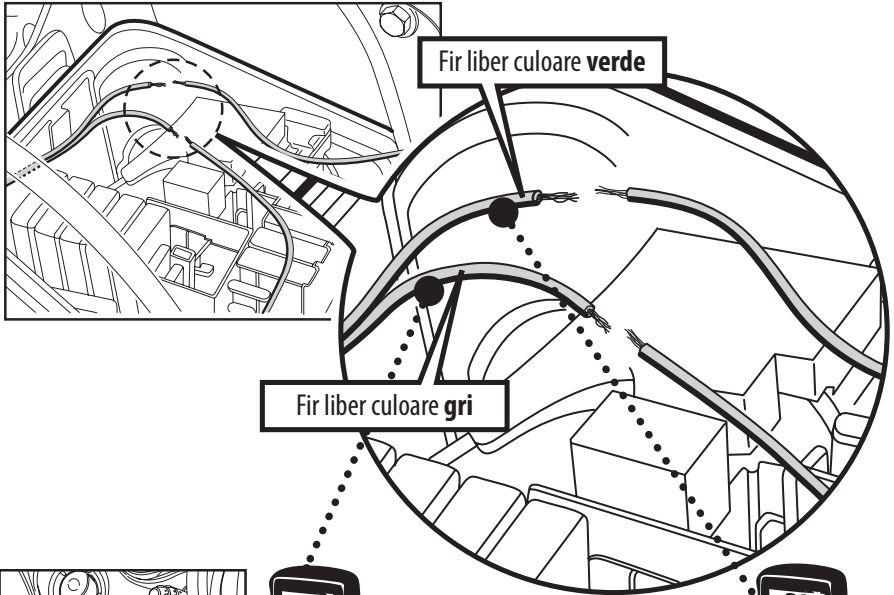

$r = 0,0 \Omega$



$r = 0,0 \Omega$

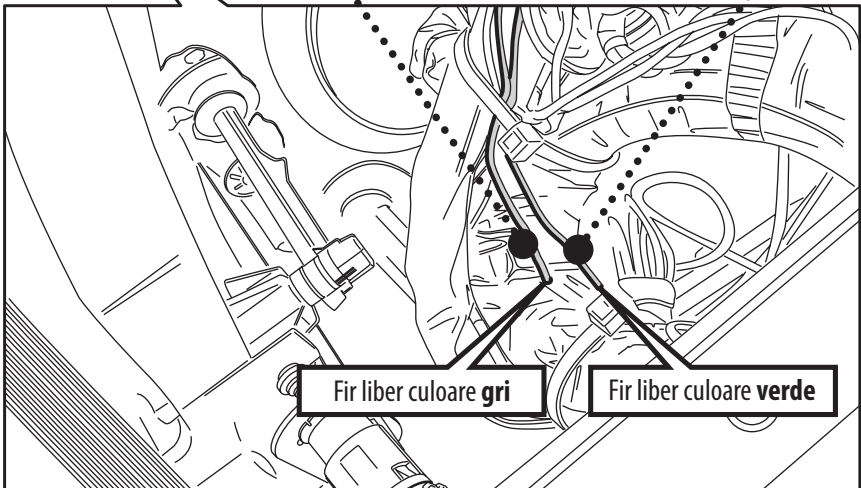

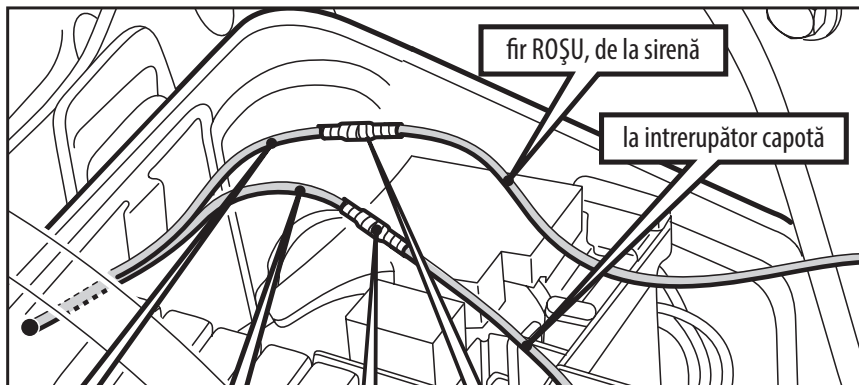

Fir liber  
culoare gri

Fir liber  
culoare verde

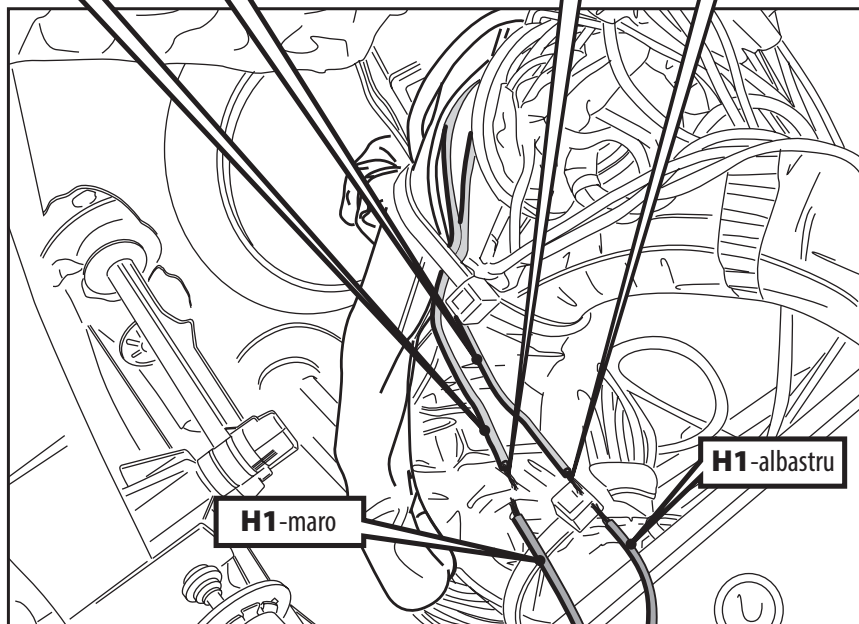
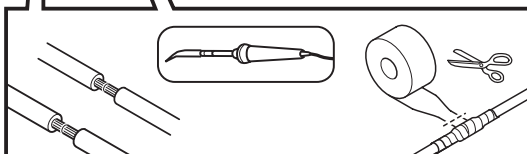

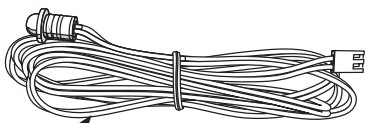

H5

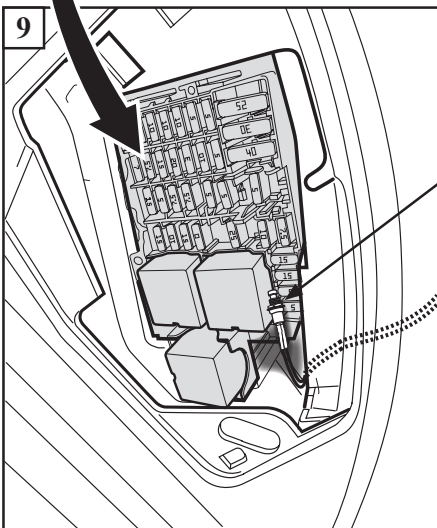
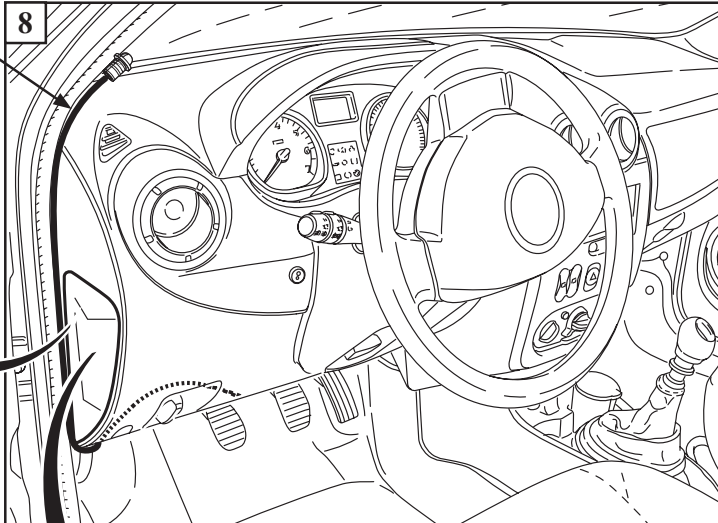

H4





10

13

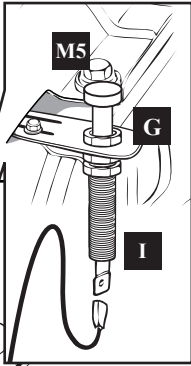
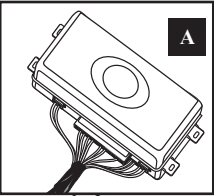

15-16

13-14



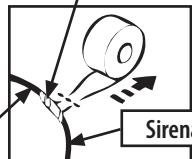
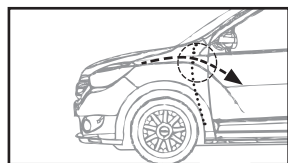

Sirenă roșu

H1 maro

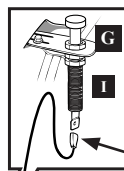

H1 albastru + P papuc



S

H1 albastru + H1 maro

Sirenă roșu

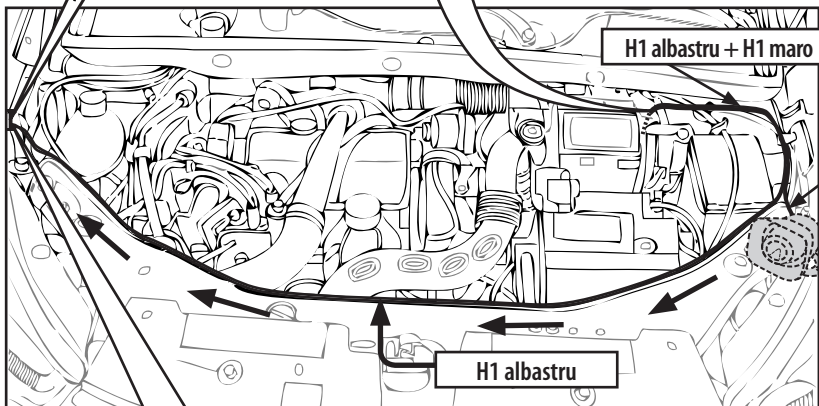

H1 albastru



S

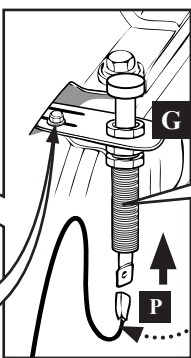
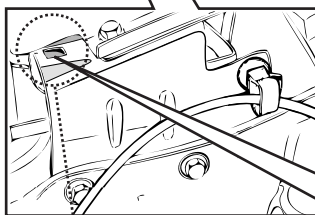

H1 albastru + papuc

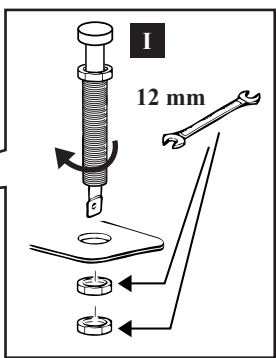

I

12 mm

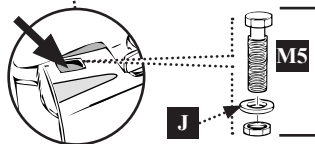

J

M5

G

P

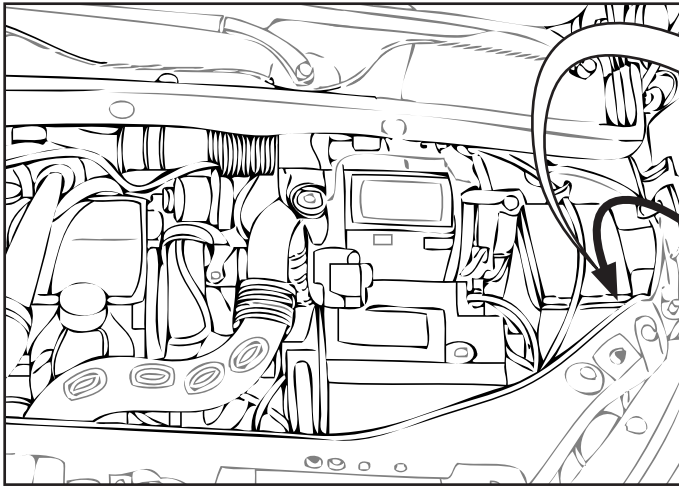

S

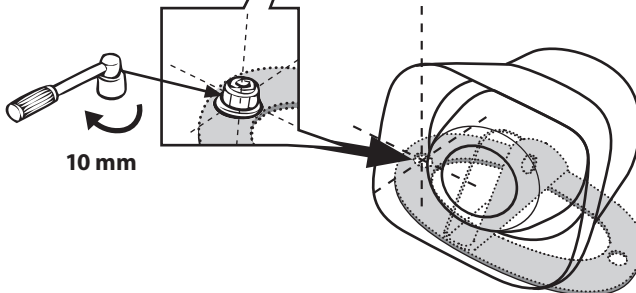
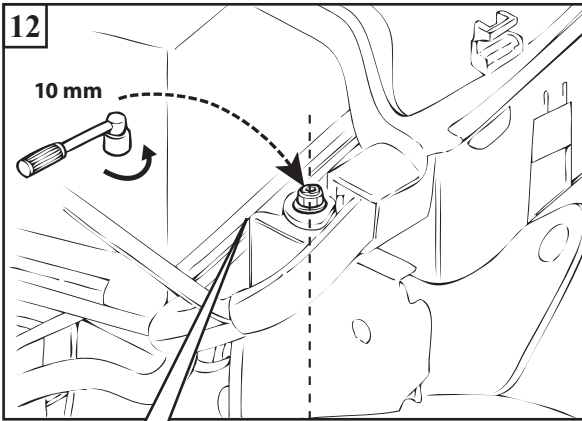

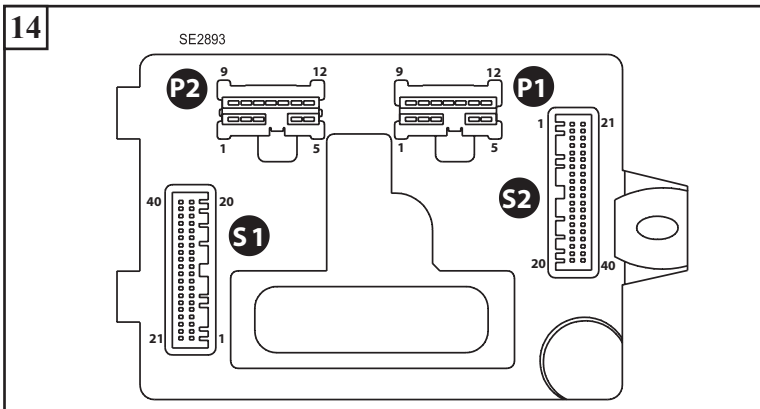
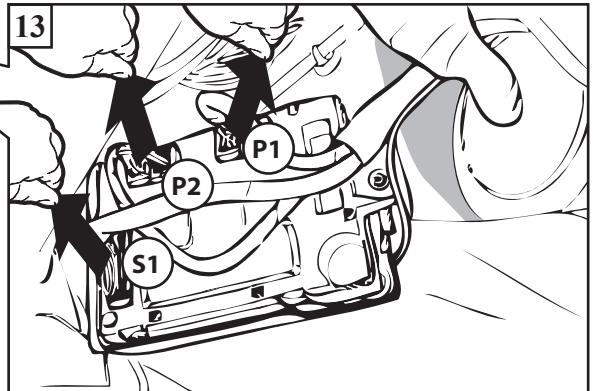
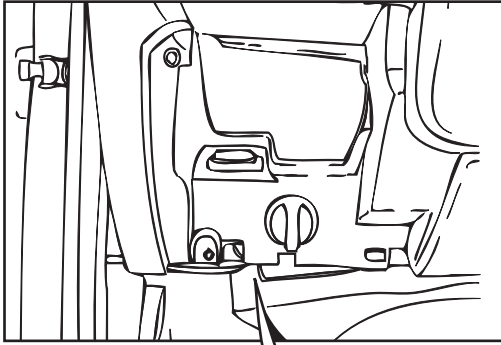

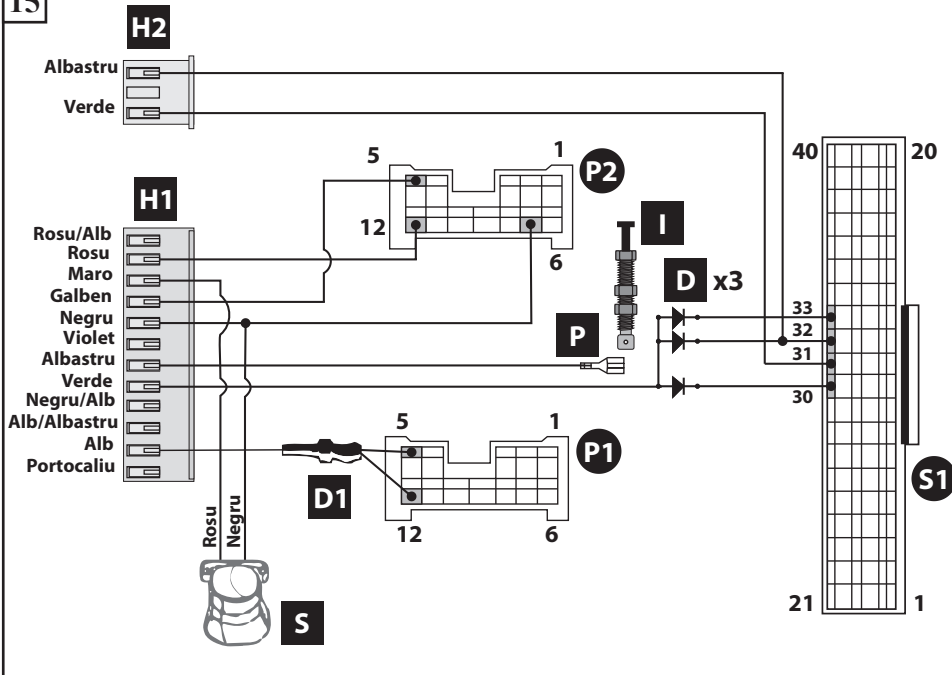

15

**ATENȚIE!**

Funcția "Inchidere centralizată controlată de contact" trebuie dezactivată.

- vezi procedura de programare a funcției 3 de la pagina 15



15

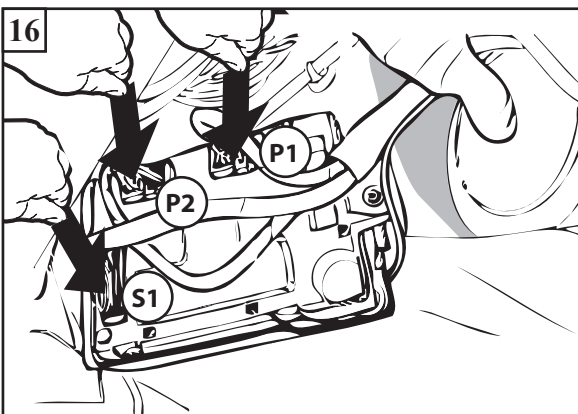

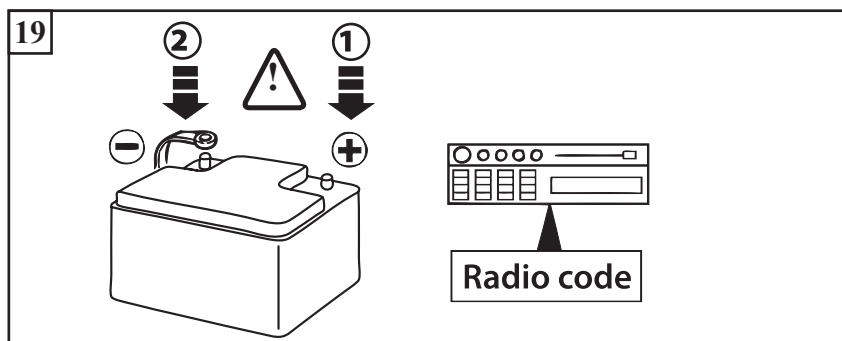
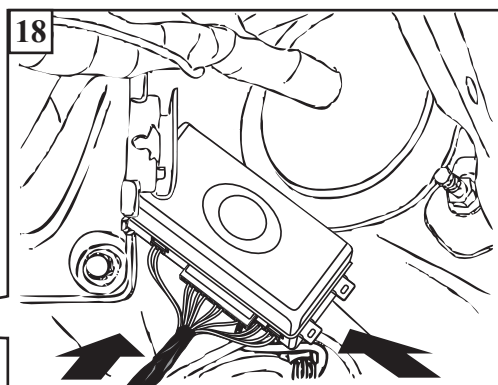
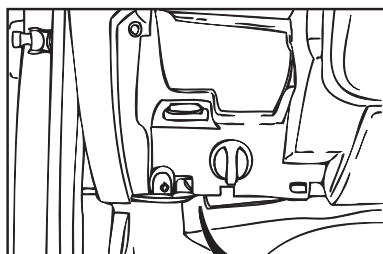
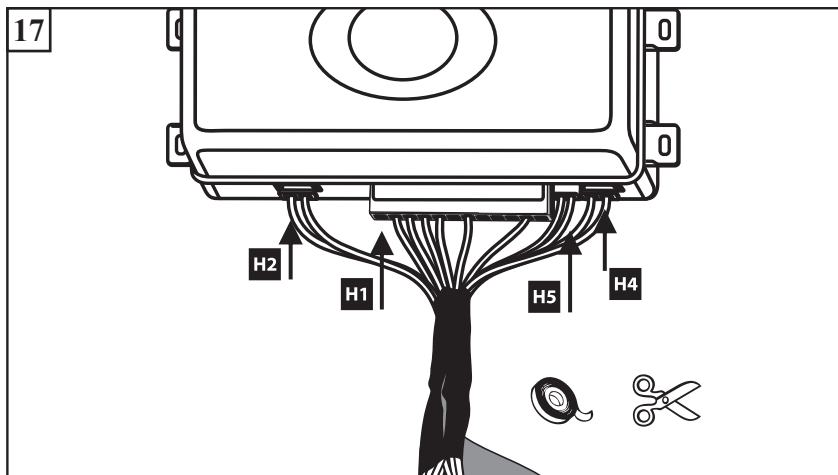

## Procedura de programare a funcției 3

### Pentru a accesa procedura:

1. Deschideți o ușă



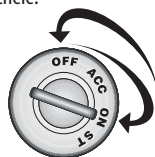

2. Puneți și apoi luați contactul cheie.

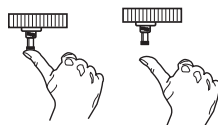

3. Alegeți: în mai puțin de 10 secunde apăsați și eliberați întrerupătorul Valet de 3 ori. Apoi apăsați întrerupătorul încă o dată și mențineți. **LED-ul va clipi de 3 ori și sirena va emite 3 sunete pentru a indica accesarea funcției 3.**



4. Transmitere: În timp ce mențineți apăsat întrerupătorul Valet apăsați butonul / . **LED-ul se va stinge. Sistemul va emite un sunet pentru a confirma programarea.**



5. Eliberați întrerupătorul Valet®.



Funcțiile scrise cu litere îngroșate sunt programate direct din fabrică.

### Funcția

# 3

**Setări implicite LED ON (Apăsați butonul de armare/dezarmare al telecomenzii)**

**Încuiere/descuiere uși controlată de plus contact activată**

Setări LED OFF (Apăsați butonul AUX al telecomenzii)

Încuiere/descuiere uși controlată de plus contact dezactivată

Pentru a ieși din procedura de învățare, faceți una dintre următoarele acțiuni:

- Închideți ușa deschisă
- Puneți contactul cheie
- Nu faceți nimic timp de 15 secunde
- Apăsați întrerupătorul Valet® de mai multe ori

# Procedura de învățare a telecomenzilor

## Pentru a accesa procedura:

1. Deschideți o ușă





2. Puneți contactul cheie.

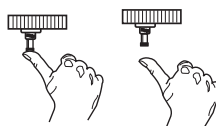

3. Alegeți: în mai puțin de 10 secunde apăsați și eliberați întrerupătorul Valet de 7 ori. Apoi apăsați întrerupătorul încă o dată și mențineți. **Sirena va emite 7 sunete și LED-ul va clipi de 7 ori.**



4. Transmite: În timp ce mențineți apăsat întrerupătorul Valet apăsați butonul  / . **LED-ul se va stinge. Sistemul va emite un sunet pentru a confirma programarea.**



5. Eliberați întrerupătorul Valet®.

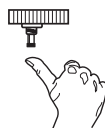

6. Luați contactul cheie.



